

1187/B7

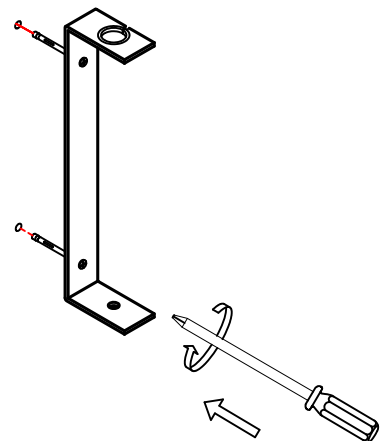

1187/B3+B4

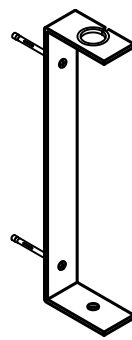
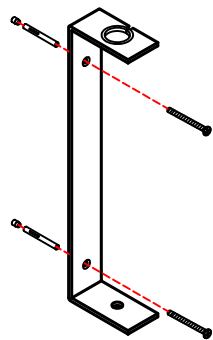
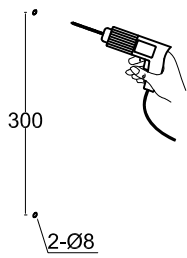
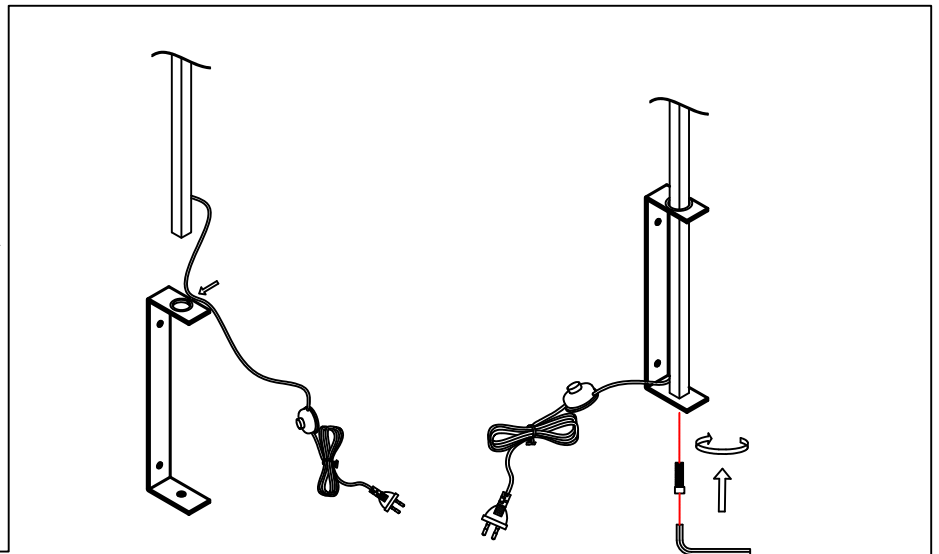
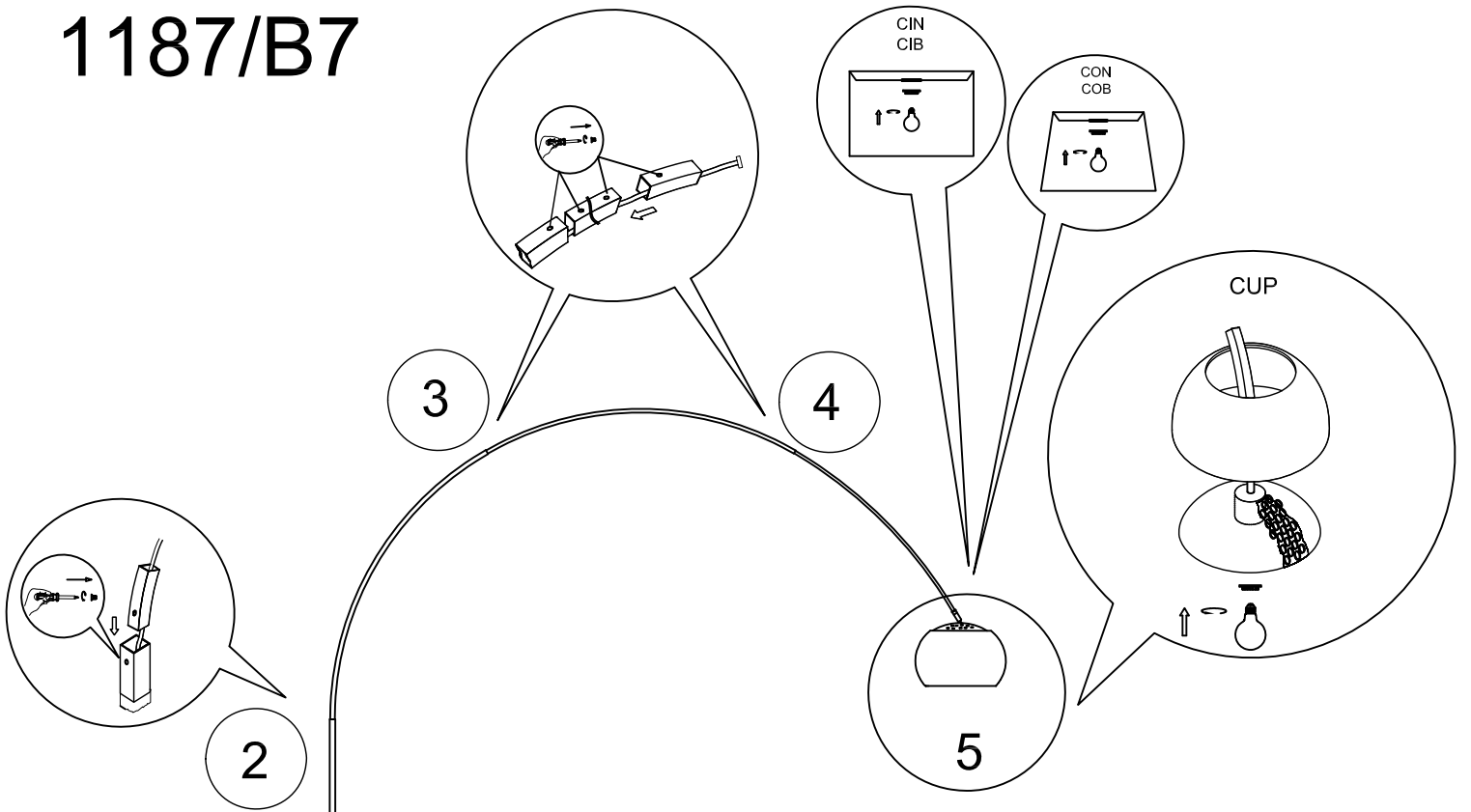
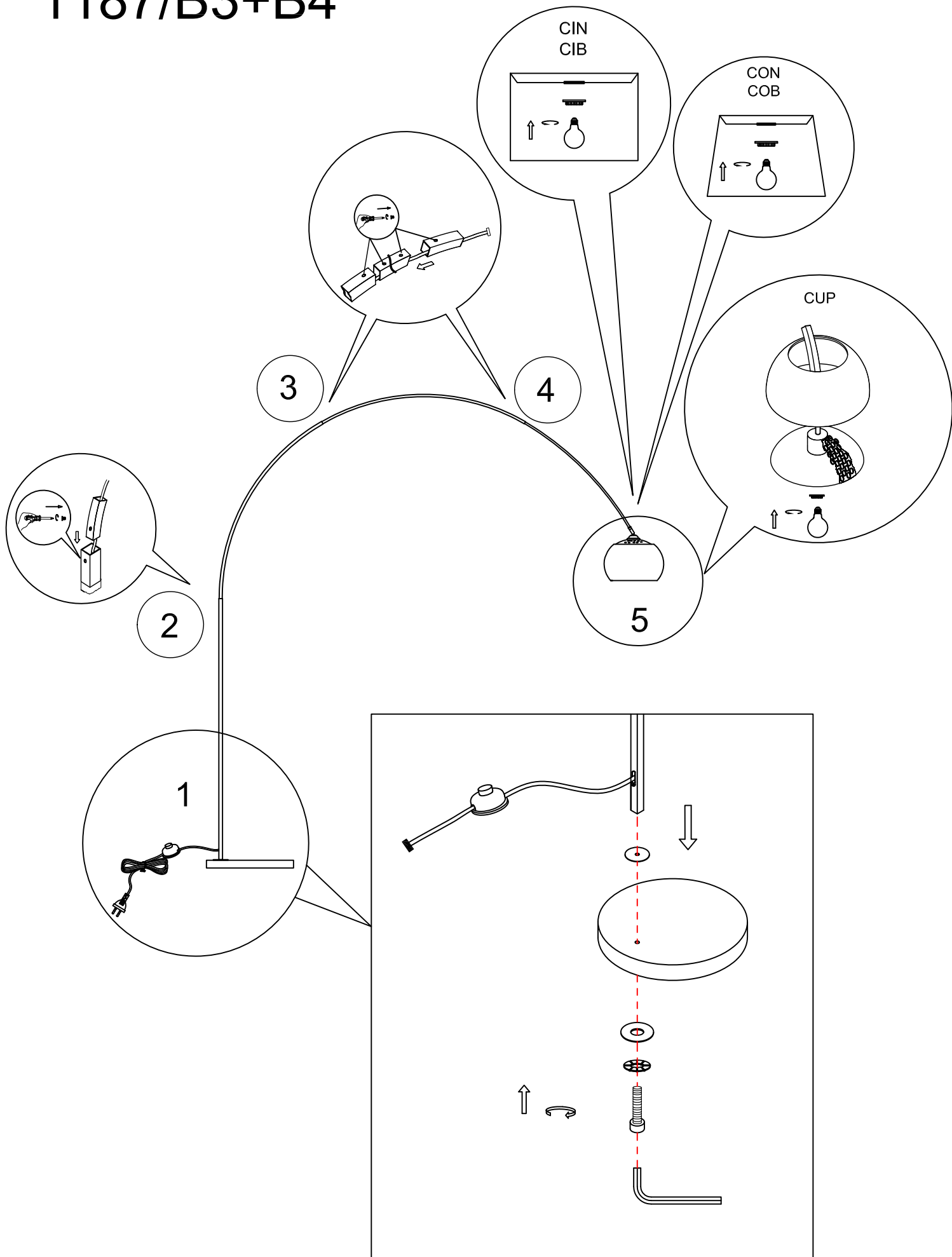

1187/B5+B6

